

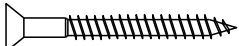

ATTENTION PLEASE
 ALTHOUGH DESIGN ON THE ASSEMBLY
 MAY DIFFER FROM THE ACTUAL BED, IT DOES NOT
 AFFECT THE WAY THE BEDS ARE ASSEMBLED.
 THIS IS FOR GUIDANCE ONLY.

| | | | |
|---|--|--|----|
| A |  |  | 20 |
| B |  |  | 20 |



"HIGH BED" BOOKSHELVES

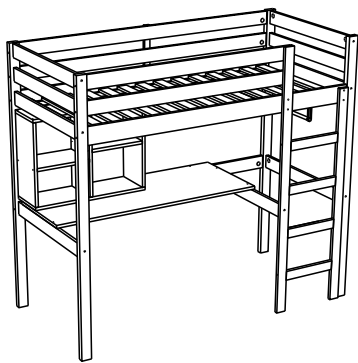
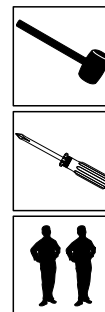
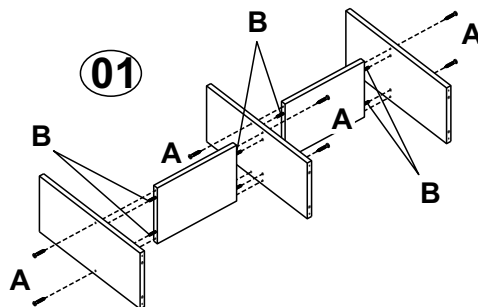

03

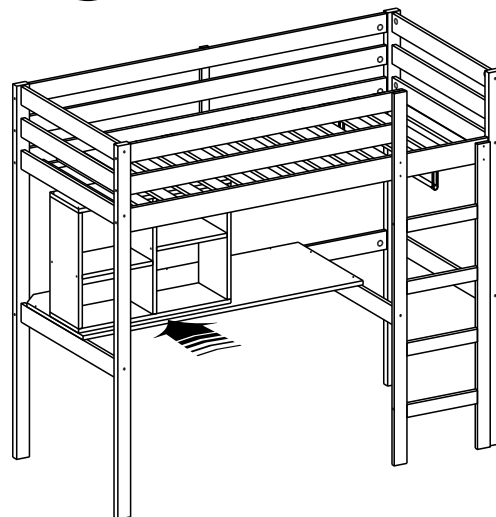

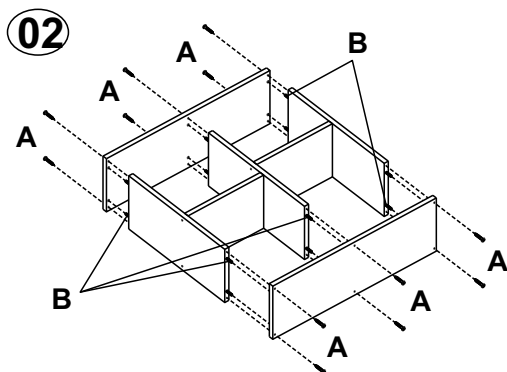
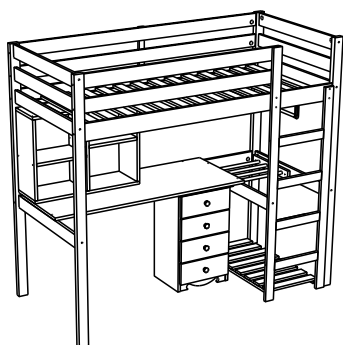

OPTIONS

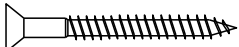

Rev.:01-18/02/2012

ATTENTION PLEASE
 ALTHOUGH DESIGN ON THE ASSEMBLY
 MAY DIFFER FROM THE ACTUAL BED, IT DOES NOT
 AFFECT THE WAY THE BEDS ARE ASSEMBLED.
 THIS IS FOR GUIDANCE ONLY.

| | | | |
|---|--|--|----|
| A |  |  | 20 |
| B |  |  | 20 |

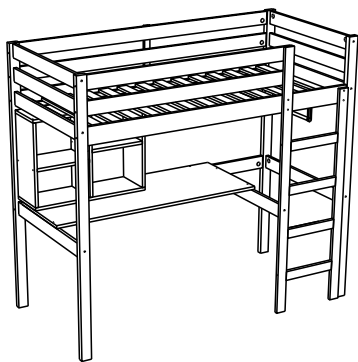
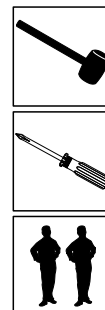

"HIGH BED" BOOKSHELVES

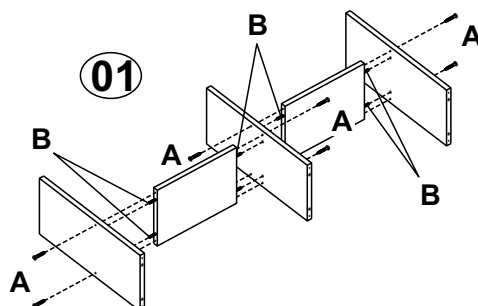

03

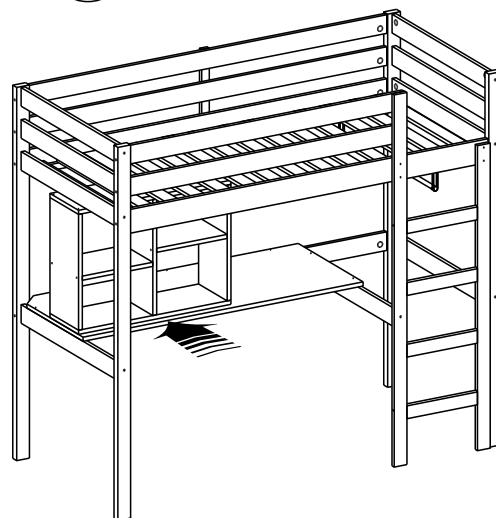

OPTIONS

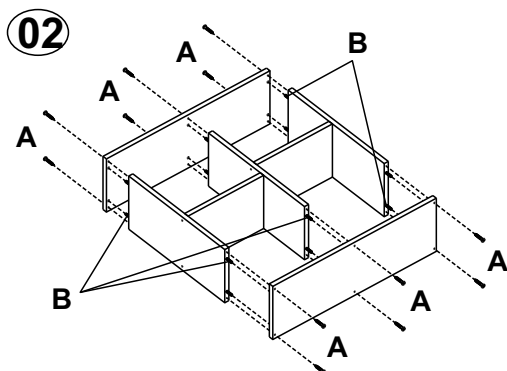
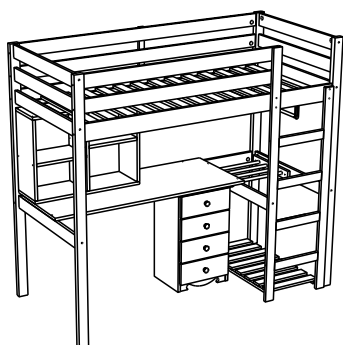

Rev.:01-18/02/2012