

ATTENTION PLEASE
 ALTHOUGH DESIGN ON THE ASSEMBLY
 MAY DIFFER FROM THE ACTUAL BED, IT DOES NOT
 AFFECT THE WAY THE BEDS ARE ASSEMBLED.
 THIS IS FOR GUIDANCE ONLY.

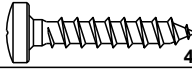

**"HIGH BED"
 HANGER**

A			4,0 x 22	04
B				02

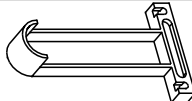
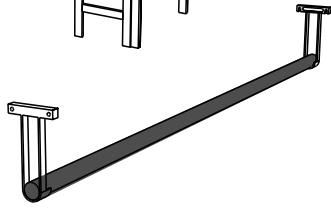
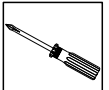

01

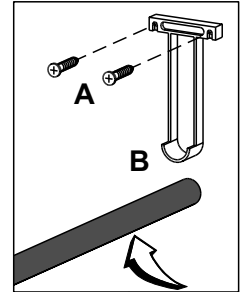
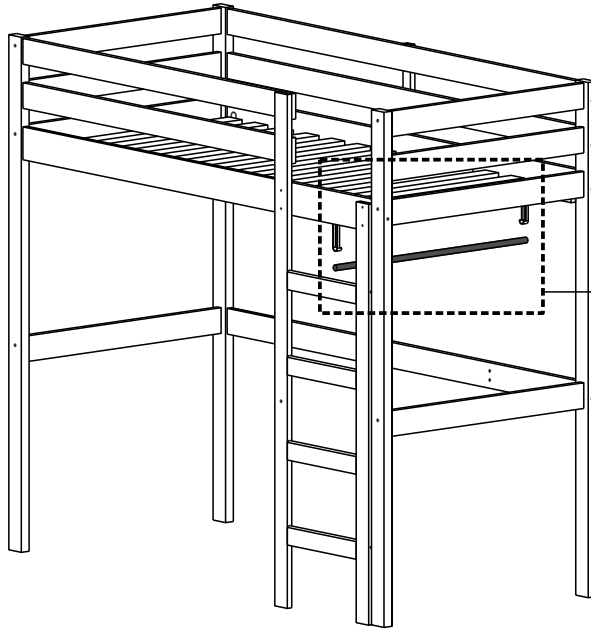

OPTIONS

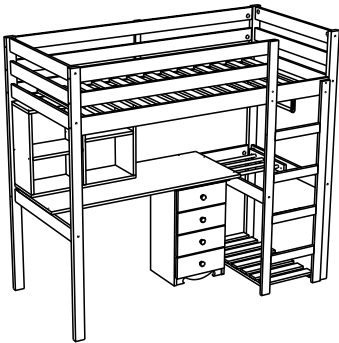



Rev.:01-05/05/2012

ATTENTION PLEASE
 ALTHOUGH DESIGN ON THE ASSEMBLY
 MAY DIFFER FROM THE ACTUAL BED, IT DOES NOT
 AFFECT THE WAY THE BEDS ARE ASSEMBLED.
 THIS IS FOR GUIDANCE ONLY.

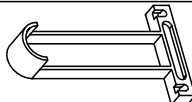

**"HIGH BED"
 HANGER**

A			4,0 x 22	04
B				02

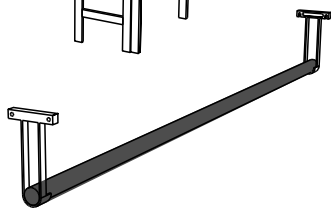
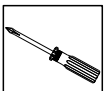

01

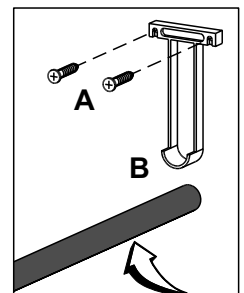
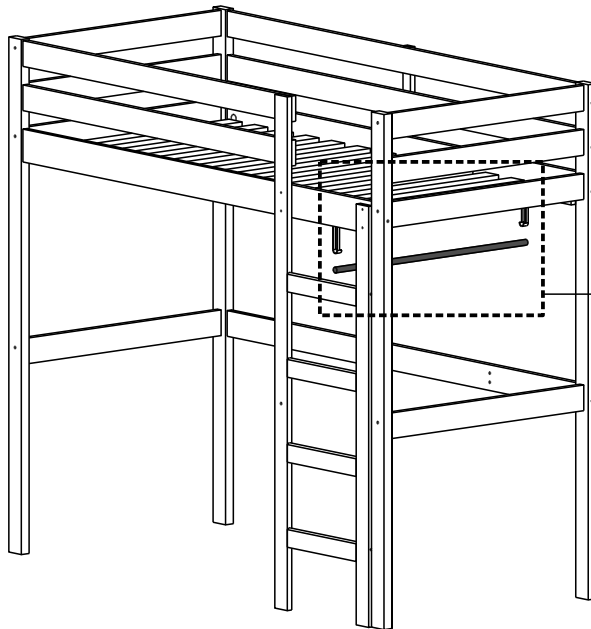

OPTIONS

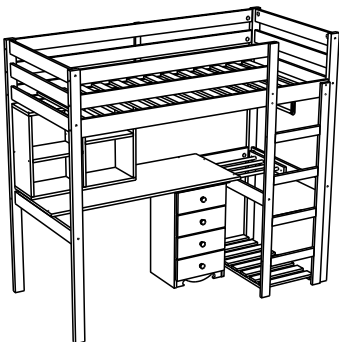

Rev.:01-05/05/2012